

Article number: 03446035

Description: Fluro Heavy Duty Spherical Plain Bearing GE 35 GW-2RS  
Hole Ø35

Note: 35

## Measures

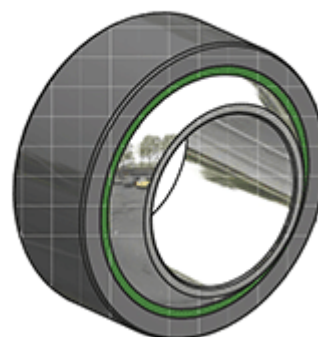
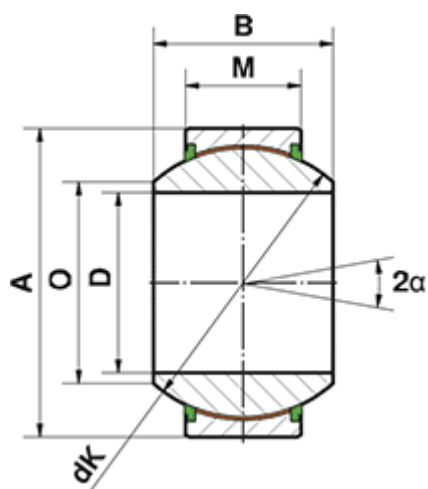

	= -	Dynamic load C (kN) = 277
	= -	M = 22
	= -	O = 39.7
A	= 62	Static load C0 (kN) = 462
a (degrees)	= 16	Weight (g) = 380
B	= 35	
D	= 35	
dK	= 53	